

TECHNICAL DATASHEET AFTC AM9408 - 0.031" THICK

PRODUCT DESCRIPTION

The AM9408 is a very strong tape with excellent initial tack and adhesion performance during application. This property and excellent adaptability properties makes the AM9408 ideal for a wide variety of applications and especially on lacquered parts and other coatings in the automotive industry.

TYPICAL APPLICATIONS

- Various high and medium surface energy plastics
- Glass
- Steel
- Aluminum
- Ceramics

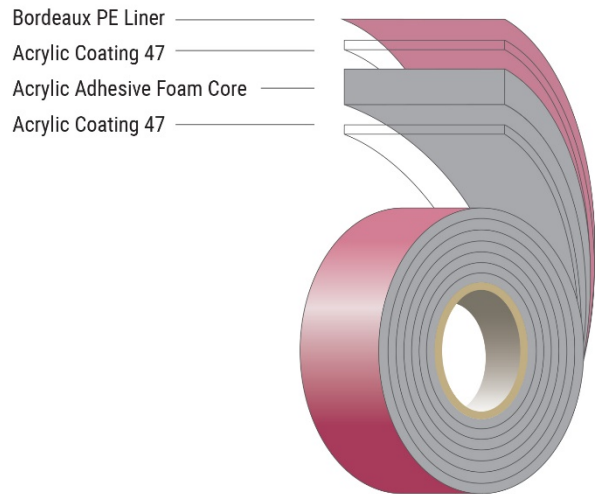

PRODUCT FEATURES & BENEFITS

- Very good shear strength, good inner strength and very good long term stability
- UV resistant
- Solvent resistant

TECHNICAL DATA	VALUE	TEST METHOD / STANDARD
THICKNESS	0.031" ±15%	
COLOR	Gray	
MATERIAL / SUBSTRATE	Coated Acrylic Foam	
CORE	Acrylic Adhesive Foam Core	
ADHESIVE TYPE	Acrylic Coating 47	
ADHESIVE SYSTEM	Permanent Adhesive	
ADHESIVE SIDE	Double Sided Adhesive	
LINER	Bordeaux PE liner	
DENSITY	52 lb/ft ³	
MINIMUM TEMPERATURE RESISTANCE	-40°F	
SHORT-TERM TEMPERATURE RESISTANCE	320°F	
LONG-TERM TEMPERATURE RESISTANCE	212°F	
90° PEEL ADHESION	19 lb/in	ASTM D3330
DYNAMIC SHEAR STRENGTH	90 lb/in ²	ASTM D1002
TENSILE STRENGTH	92 lb/in ²	ASTM D897
STATIC SHEAR STRENGTH @ 72°F	1,000 grams*	ASTM 3654
STATIC SHEAR STRENGTH @ 150°F	500 grams*	ASTM 3654
STATIC SHEAR STRENGTH @ 200°F	500 grams*	ASTM 3654
CELL STRUCTURE	Closed Cell	
SOLVENT RESISTANCE	Excellent	

Specifications are believed to be accurate at the time of publication and are subject to change without notice. It is the responsibility of the end-user to test and determine suitability of this material for a particular application. **REV. 0**

TECHNICAL DATASHEET AFTC AM9408 - 0.031" THICK

UV RESISTANCE	Excellent	
RECOMMENDED APPLICATION TEMPERATURE	Minimum 59°F	

NOTES: *Weight that 1/2 square inch will hold 10,000 minutes (7 days).

SHELF LIFE/STORAGE	
SHELF LIFE	18 months
RECOMMENDED STORAGE CONDITIONS	Store in its original package and in a dry place between 39.2°F and 100.4°F

CLEANING

To clean your light and medium contaminated substrates, use an isopropanol/alcohol solution (IPA). When cleaning your substrate, a tear free, light colored paper towel is required. Wipe the substrate in one direction using the one cloth method (one cloth with cleaner) or a two-cloth method (one cloth with cleaner and one dry cloth to follow) is acceptable if you are short on time. Repeat these steps until your cloth is clean and free of any contaminants. For heavily contaminated substrates, use a cleaning agent such as MEK, Heptan or Acetone. These cleaning agents may leave a residue which would have to be removed using the IPA cleaner.

ABRASION

When bonding to raw aluminum, abrading of the surface is a must. The oils used in the waltzing of the aluminum are pressed into the pores of the material. To remove these oils, that will influence the bond, we recommend using abrasive pads to ensure the proper level of abrasion without damaging your substrates. Besides raw aluminum, abrading is a method utilized to help improve your bond. After the abrasion process is completed, remove any residue using an IPA cleaner following the methods mentioned above.

PRIMER

The use of a primer is recommended when bonding to some low surface energy substrates. Examples include, different types of polymers, powder coated metals, or porous materials such as wood, cork, stone or concrete. Primers are also used to help speed up your production process. The AFTC line can take up to 72 hours to reach its end-strength. The use of a primer ensures the end-strength will be achieved within 20 minutes. H-O Products offers two primers; the primer 33 and the primer 101. Determining which one of these primers is suitable for your application ultimately depends on the substrates and environmental influences.

PRESSURE

AFTC tapes are pressure sensitive adhesives. Therefore, a minimum amount of pressure is required on the bond line to ensure the maximum adhesion to your substrates. This pressure should be applied in a rolling fashion. A hand roller or mechanical presser are the preferred methods. The pressure on the bond line must be a minimum of at least 14.5 psi.

Specifications are believed to be accurate at the time of publication and are subject to change without notice. It is the responsibility of the end-user to test and determine suitability of this material for a particular application. **REV. 0**